

Datasheet

HBPR-100M-60K-IN-FC

High-Speed Balanced Photoreceiver

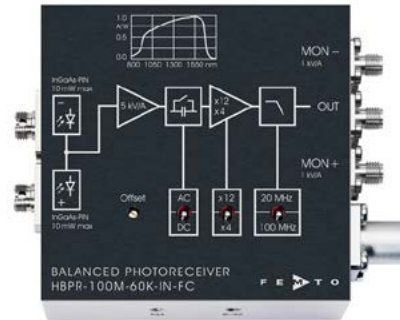

Features

- Bandwidth DC to 100 MHz
- Common-Mode Rejection Ratio (CMRR) 55 dB typ.
- InGaAs-PIN photodiodes
- FC fiber optic inputs
- Spectral range 900 - 1700 nm
- Very low NEP, down to 3.7 pW/√Hz
- Transimpedance gain switchable 20 x 10³ V/A, 60 x 10³ V/A
- High dynamic input range up to 2 x 10 mW balanced optical power
- Fast monitor outputs with 10 MHz bandwidth and 1 x 10³ V/A gain
- Switchable low pass filter for minimizing wideband noise
- UNC 8-32 and M4 tapped holes for mounting on standard posts with metric and imperial thread

Applications

- Spectroscopy
- Heterodyne detection
- Optical coherence tomography (OCT)
- Optical delay measurement
- Differential optical front-end for oscilloscopes, spectrum analyzers, A/D converters and RF lock-in amplifiers

Block Diagram

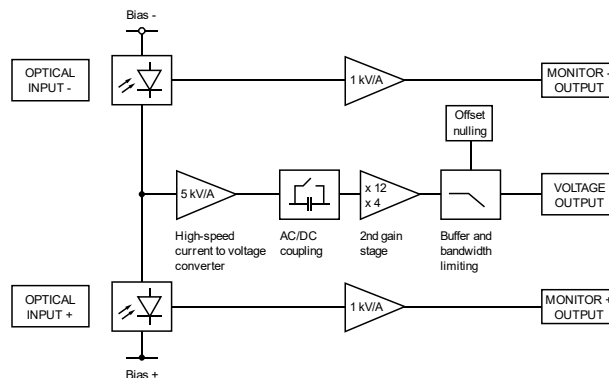

SOPHISTICATED TOOLS FOR SIGNAL RECOVERY





HBPR-100M-60K-IN-FC_R2/TH/08APR2021

06/22 / V3 / CHHW / femto/balanced-photoreceiver-series-hbpr-100m-60k-in-fc

Datasheet

HBPR-100M-60K-IN-FC

High-Speed Balanced Photoreceiver

<p>Available Input Version</p>	<p>HBPR-100M-60K-IN-FC</p>  <p>fix/permanent FC fiber connector for high coupling efficiency, excellent conversion gain accuracy and common mode rejection ratio (CMRR).</p>																												
<p>Related Models</p>	<p>Various free space or fiber coupled HBPR models, with bandwidth up to 500 MHz, in the spectral range from 320 nm to 1700 nm are available.</p> <p>Example: FST input</p>  <p>1.035"-40 threaded flange for free space applications, compatible with many optical standard accessories.</p> <p>See further information and separate datasheets on www.femto.de</p>																												
<p>Available Accessory</p>	<p>PS-15</p>  <p>power supply, input: 100 - 240 VAC, output: ± 15 VDC, +400/-250 mA</p>																												
<p>Specifications</p>	<table border="0"> <tr> <td>Test conditions</td> <td>$V_S = \pm 15$ V, $T_A = 25$ °C, signal output terminated with 50 Ω, Monitor outputs terminated with 1 MΩ</td> </tr> <tr> <td rowspan="4">Gain</td> <td>Transimpedance gain</td> <td>20 x 10³ V/A (2nd gain x4), 60 x 10³ V/A (2nd gain x12) switchable (@ 50 Ω load)</td> </tr> <tr> <td>Gain accuracy</td> <td>± 1 % electrical</td> </tr> <tr> <td>Conversion gain</td> <td>19 x 10³ V/W typ. (@ 2nd gain x4, 1550 nm) 57 x 10³ V/W typ. (@ 2nd gain x12, 1550 nm)</td> </tr> <tr> <td>Common mode rejection ratio (CMRR)</td> <td>55 dB typ. (f \leq 100 MHz)</td> </tr> <tr> <td rowspan="2">Frequency Response</td> <td>Lower cut-off frequency</td> <td>DC / 10 Hz, switchable</td> </tr> <tr> <td>Upper cut-off frequency</td> <td>100 MHz, switchable to 20 MHz</td> </tr> <tr> <td rowspan="2">Time Response</td> <td>Rise/fall time (10 % - 90 %)</td> <td>3.2 ns 17.5 ns (low pass filter 20 MHz)</td> </tr> <tr> <td rowspan="5">Input</td> <td>Noise equivalent power (NEP)</td> <td>minimum 3.7 pW/$\sqrt{\text{Hz}}$ (@ 1550 nm) 4.0 pW/$\sqrt{\text{Hz}}$ (@ 1550 nm, 20 MHz) 5.8 pW/$\sqrt{\text{Hz}}$ (@ 1550 nm, 50 MHz) 8.6 pW/$\sqrt{\text{Hz}}$ (@ 1550 nm, 100 MHz)</td> </tr> <tr> <td>Maximum differential CW power for linear amplification</td> <td>53 μW (@ 2nd gain x4, DC-coupled, 1550 nm) 18 μW (@ 2nd gain x12, DC-coupled, 1550 nm) 275 μW (@ AC-coupled, 1550 nm)</td> </tr> <tr> <td>Max. optical CW balanced power (common mode power)</td> <td>10 mW (on each photodiode, @ 1550 nm)</td> </tr> <tr> <td>Monitor optical saturation power (limited for linear amplification)</td> <td>10.5 mW (@ 1550 nm)</td> </tr> </table>	Test conditions	$V_S = \pm 15$ V, $T_A = 25$ °C, signal output terminated with 50 Ω , Monitor outputs terminated with 1 M Ω	Gain	Transimpedance gain	20 x 10 ³ V/A (2 nd gain x4), 60 x 10 ³ V/A (2 nd gain x12) switchable (@ 50 Ω load)	Gain accuracy	± 1 % electrical	Conversion gain	19 x 10 ³ V/W typ. (@ 2 nd gain x4, 1550 nm) 57 x 10 ³ V/W typ. (@ 2 nd gain x12, 1550 nm)	Common mode rejection ratio (CMRR)	55 dB typ. (f \leq 100 MHz)	Frequency Response	Lower cut-off frequency	DC / 10 Hz, switchable	Upper cut-off frequency	100 MHz, switchable to 20 MHz	Time Response	Rise/fall time (10 % - 90 %)	3.2 ns 17.5 ns (low pass filter 20 MHz)	Input	Noise equivalent power (NEP)	minimum 3.7 pW/ $\sqrt{\text{Hz}}$ (@ 1550 nm) 4.0 pW/ $\sqrt{\text{Hz}}$ (@ 1550 nm, 20 MHz) 5.8 pW/ $\sqrt{\text{Hz}}$ (@ 1550 nm, 50 MHz) 8.6 pW/ $\sqrt{\text{Hz}}$ (@ 1550 nm, 100 MHz)	Maximum differential CW power for linear amplification	53 μ W (@ 2 nd gain x4, DC-coupled, 1550 nm) 18 μ W (@ 2 nd gain x12, DC-coupled, 1550 nm) 275 μ W (@ AC-coupled, 1550 nm)	Max. optical CW balanced power (common mode power)	10 mW (on each photodiode, @ 1550 nm)	Monitor optical saturation power (limited for linear amplification)	10.5 mW (@ 1550 nm)
Test conditions	$V_S = \pm 15$ V, $T_A = 25$ °C, signal output terminated with 50 Ω , Monitor outputs terminated with 1 M Ω																												
Gain	Transimpedance gain	20 x 10 ³ V/A (2 nd gain x4), 60 x 10 ³ V/A (2 nd gain x12) switchable (@ 50 Ω load)																											
	Gain accuracy	± 1 % electrical																											
	Conversion gain	19 x 10 ³ V/W typ. (@ 2 nd gain x4, 1550 nm) 57 x 10 ³ V/W typ. (@ 2 nd gain x12, 1550 nm)																											
	Common mode rejection ratio (CMRR)	55 dB typ. (f \leq 100 MHz)																											
Frequency Response	Lower cut-off frequency	DC / 10 Hz, switchable																											
	Upper cut-off frequency	100 MHz, switchable to 20 MHz																											
Time Response	Rise/fall time (10 % - 90 %)	3.2 ns 17.5 ns (low pass filter 20 MHz)																											
	Input	Noise equivalent power (NEP)	minimum 3.7 pW/ $\sqrt{\text{Hz}}$ (@ 1550 nm) 4.0 pW/ $\sqrt{\text{Hz}}$ (@ 1550 nm, 20 MHz) 5.8 pW/ $\sqrt{\text{Hz}}$ (@ 1550 nm, 50 MHz) 8.6 pW/ $\sqrt{\text{Hz}}$ (@ 1550 nm, 100 MHz)																										
Maximum differential CW power for linear amplification		53 μ W (@ 2 nd gain x4, DC-coupled, 1550 nm) 18 μ W (@ 2 nd gain x12, DC-coupled, 1550 nm) 275 μ W (@ AC-coupled, 1550 nm)																											
Max. optical CW balanced power (common mode power)		10 mW (on each photodiode, @ 1550 nm)																											
Monitor optical saturation power (limited for linear amplification)		10.5 mW (@ 1550 nm)																											

SOPHISTICATED TOOLS FOR SIGNAL RECOVERY



Datasheet

HBPR-100M-60K-IN-FC

High-Speed Balanced Photoreceiver

Specifications (continued)

Detector	Detector	InGaAs-PIN photodiode FC fiber connector	
	Active area	Ø 80 µm, integrated ball lens suitable for fibers up to 50 µm core diameter	
	Spectral range	900 - 1700 nm	
	Sensitivity	0.95 A/W typ. (@ 1550 nm)	
Signal Output	Output voltage range	±1.0 V (@ 50 Ω load) for linear operation and low harmonic distortion	
	Max. output voltage	±2.0 V (@ 50 Ω load)	
	Offset voltage compensation	±100 mV typ., adjustable by offset potentiometer	
	Output impedance	50 Ω (terminate with 50 Ω load)	
	Slew rate	2000 V/µs	
	Max. output current	70 mA	
	Output return loss S22	-30 dB @ < 100 MHz -20 dB @ < 800 MHz	
	Output noise	1.9 mV _{RMS} (13 mV _{PP}) (@ 2 nd gain x4) 5.4 mV _{RMS} (36 mV _{PP}) (@ 2 nd gain x12) 0.5 mV _{RMS} (3.1 mV _{PP}) typ. (@ 2 nd gain x4, BW: 20 MHz) 1.3 mV _{RMS} (8.6 mV _{PP}) typ. (@ 2 nd gain x12, BW: 20 MHz) (@ 50 Ω load, no signal on detectors, measurement bandwidth 2 GHz)	
	Monitor Outputs	Monitor output gain	1 x 10 ³ V/A (@ ≥ 100 kΩ load)
		Monitor output voltage range	0 ... +10 V (@ ≥ 100 kΩ load)
Monitor output impedance		50 Ω (terminate with ≥ 100 kΩ load)	
Monitor output max. output current		30 mA typ.	
Monitor output bandwidth		DC ... 10 MHz	
Monitor output noise		0.6 mV _{RMS} (4 mV _{PP}) (@ 100 kΩ load, no signal on detectors, measurement bandwidth 200 MHz)	
Power Supply	Supply voltage	±15 V (±14.5 V ... ±16.5 V)	
	Supply current	-90 / +120 mA (depends on operating conditions, recommended power supply capability min. ±200 mA)	
Case	Weight	350 g (0.77 lbs)	
	Material	AlMg3Mn, nickel-plated	
Temperature Range	Storage temperature	-40 ... +85 °C	
	Operating temperature	0 ... +60 °C	
Absolute Maximum Ratings	Max. CW power (averaged)	12 mW (on each photodiode)	
	Power supply voltage	±20 V	

SOPHISTICATED TOOLS FOR SIGNAL RECOVERY



Datasheet

HBPR-100M-60K-IN-FC

High-Speed Balanced Photoreceiver

Connectors	Input	FC fiber optic connector (FC/PC and FC/APC compatible)
	Output	SMA jack (female)
	Power supply	Lemo® series 1S, 3-pin fixed socket (mating plug type: FFA.1S.303.CLAC52)

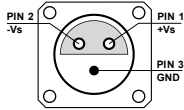

PIN 1: +15 V
PIN 2: -15 V
PIN 3: GND

Scope of Delivery	HBPR-100M-60K-IN-FC, Lemo® 3-pin connector, 3 x adapter SMA (male) to BNC (female), datasheet	
-------------------	-----------------------------------------------------------------------------------------------	--

Ordering Information	HBPR-100M-60K-IN-FC	FC fiber optic connector (FC/PC and FC/APC compatible)
----------------------	---------------------	--------------------------------------------------------

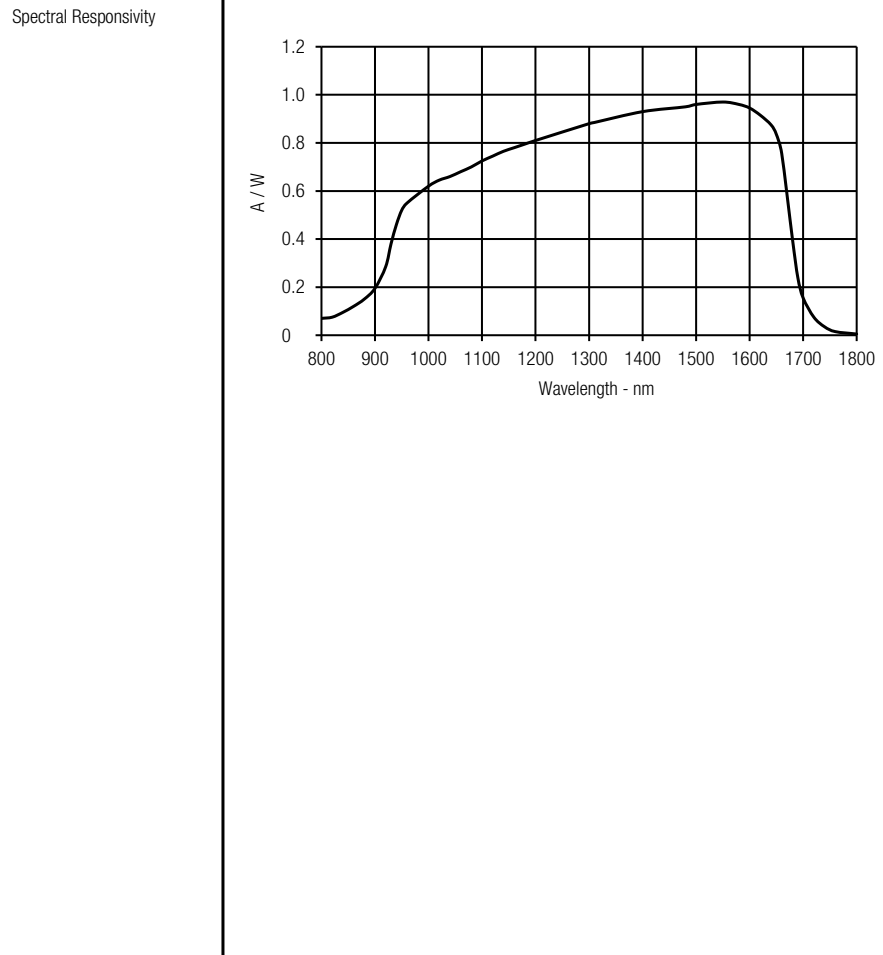

SOPHISTICATED TOOLS FOR SIGNAL RECOVERY



Datasheet

HBPR-100M-60K-IN-FC

High-Speed Balanced Photoreceiver

Dimensions

Case dimensions for HBPR-100M-60K-IN-FC:

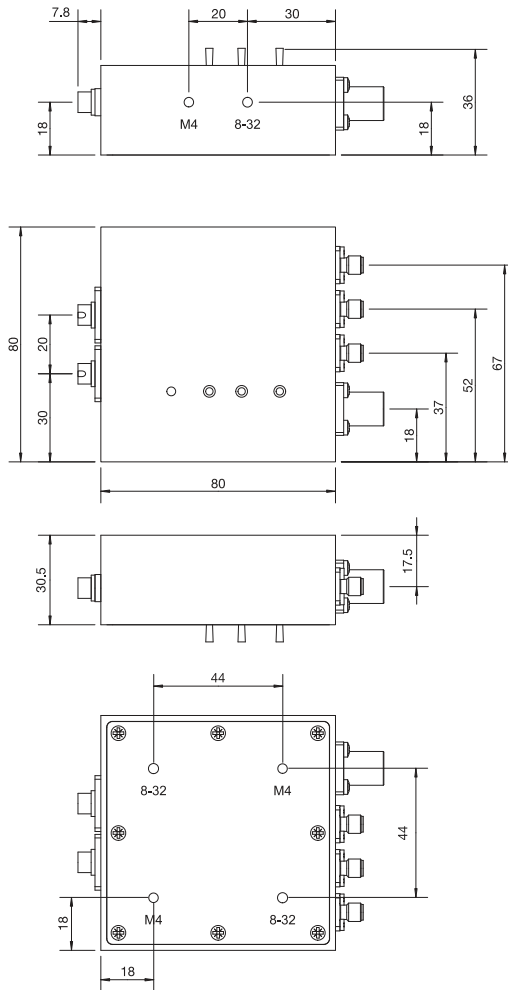

All measures in mm unless otherwise noted.

The bottom plate may be rotated to match the appropriate mounting thread to the optical axis by unscrewing the 8 screws.

Specifications are subject to change without notice. Information provided herein is believed to be accurate and reliable. However, no responsibility is assumed by FEMTO Messtechnik GmbH for its use, nor for any infringement of patents or other rights of third parties which may result from its use. No license is granted by implication or otherwise under any patent or patent rights of FEMTO Messtechnik GmbH. Product names mentioned may also be trademarks used here for identification purposes only.

© by FEMTO Messtechnik GmbH · Printed in Germany

SOPHISTICATED TOOLS FOR SIGNAL RECOVERY

